

ROVIS — Rosetta visualisation and (much) more

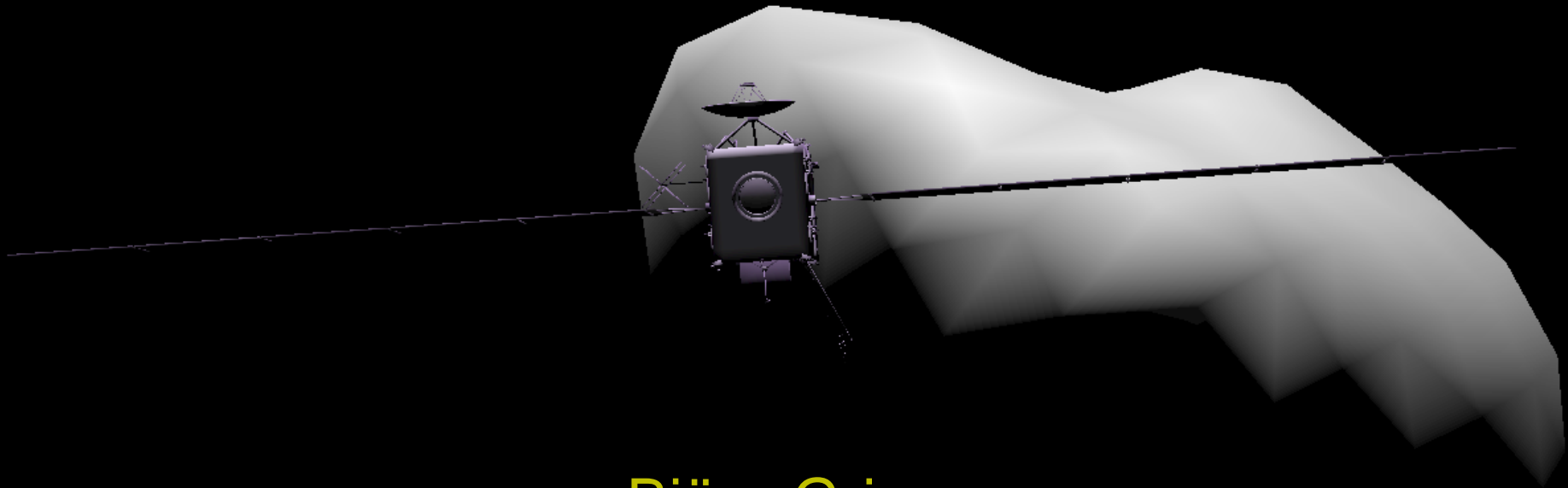

Björn Grieger

Trajectories and Operations Simulations (TOS)

Rosetta SGS Development

ESA/ESAC, Madrid, Spain

Rosetta Visualisation and Modelling

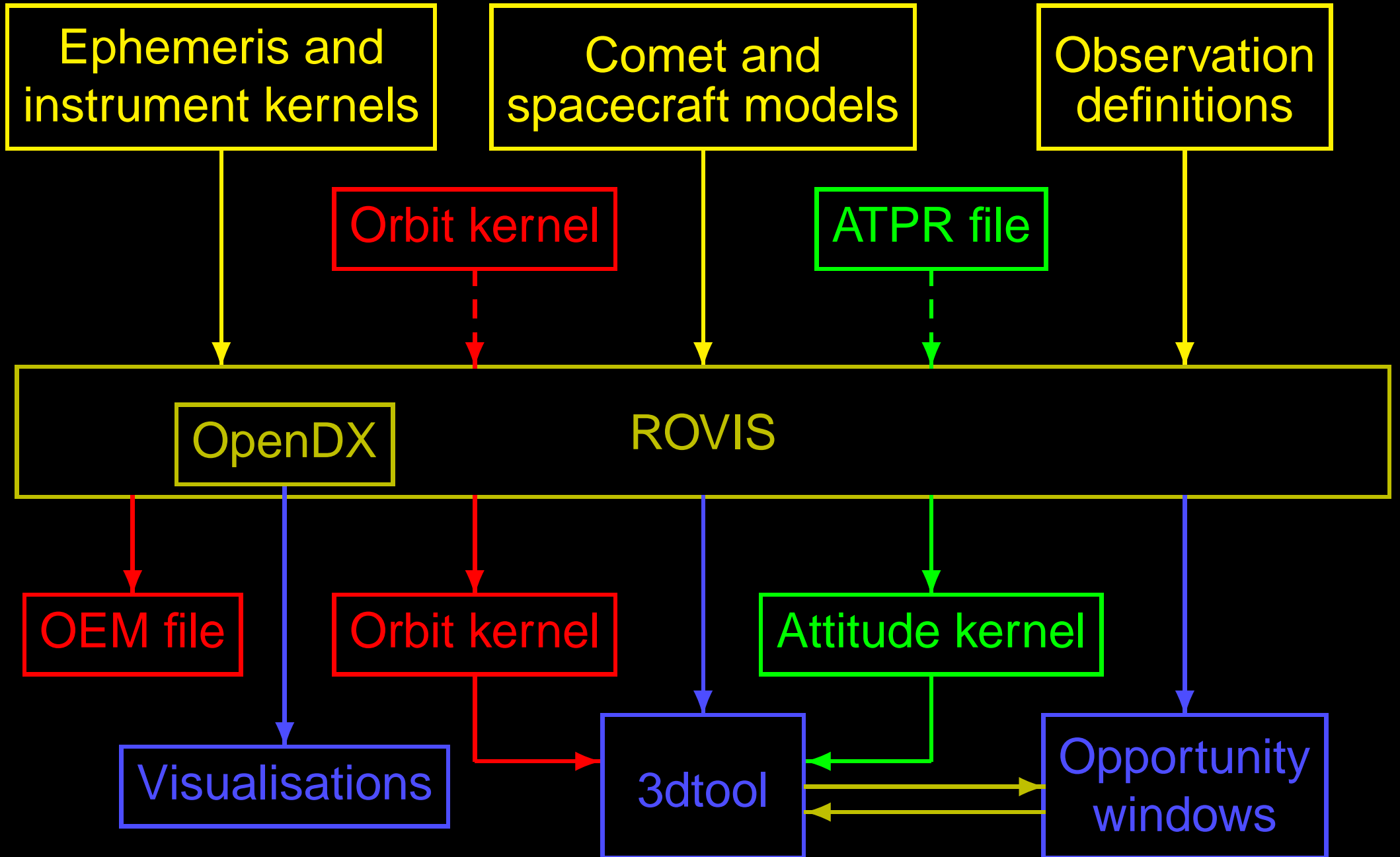

Opportunity window example

→ <http://comsim.esac.esa.int/rossim/bgrieger/timeline.html>

→ [roviz_2012-04-03.mpg](#)

Skeleton Plan Workflow

Liaison
scientists

MAPPS

ROVIS

3dtool

Science
Working Team

Skeleton Plan Workflow

Liaison
scientists

MAPPS

OEM file

ROVIS

Orbit kernel

3dtool

Science
Working Team

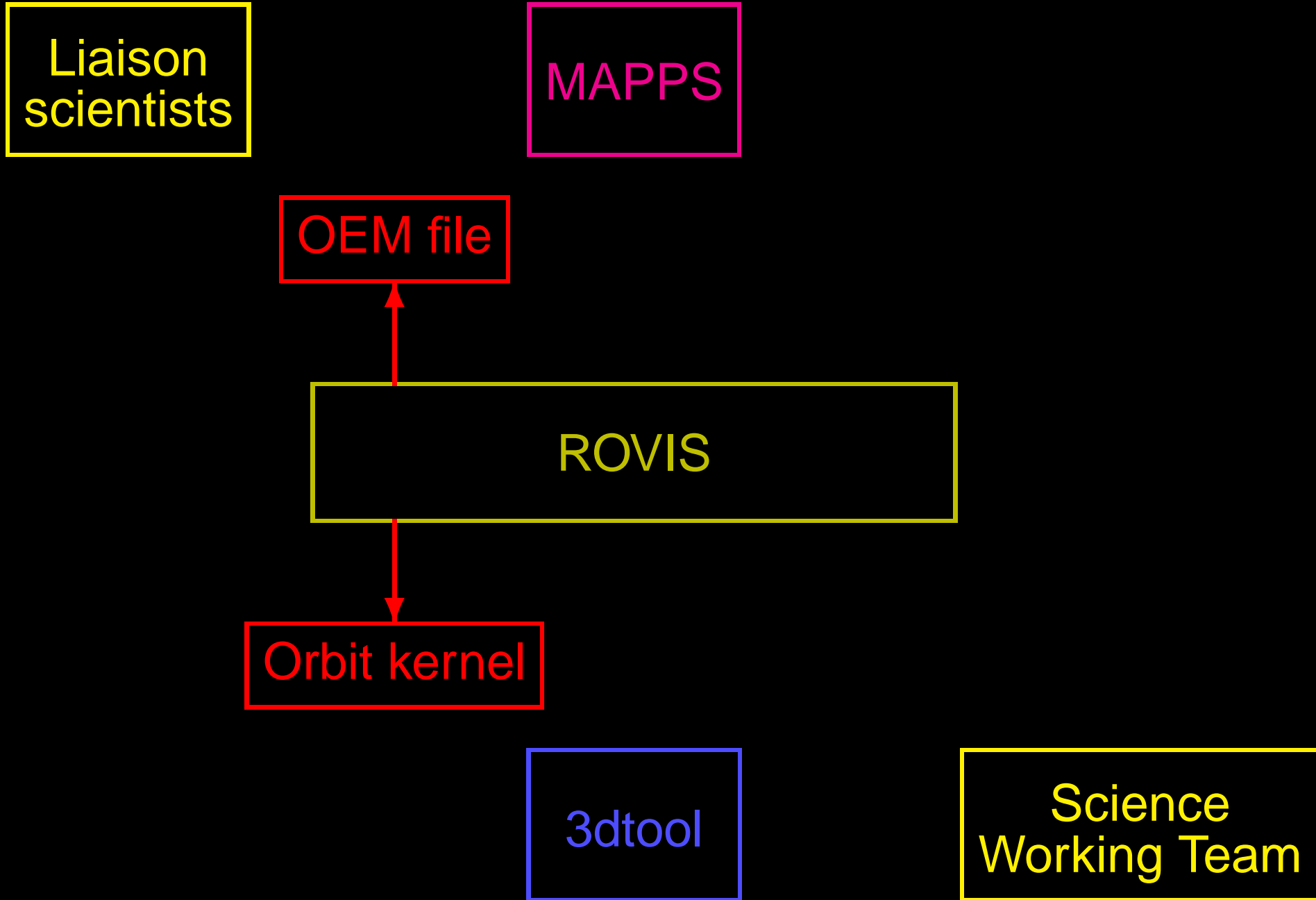

Skeleton Plan Workflow

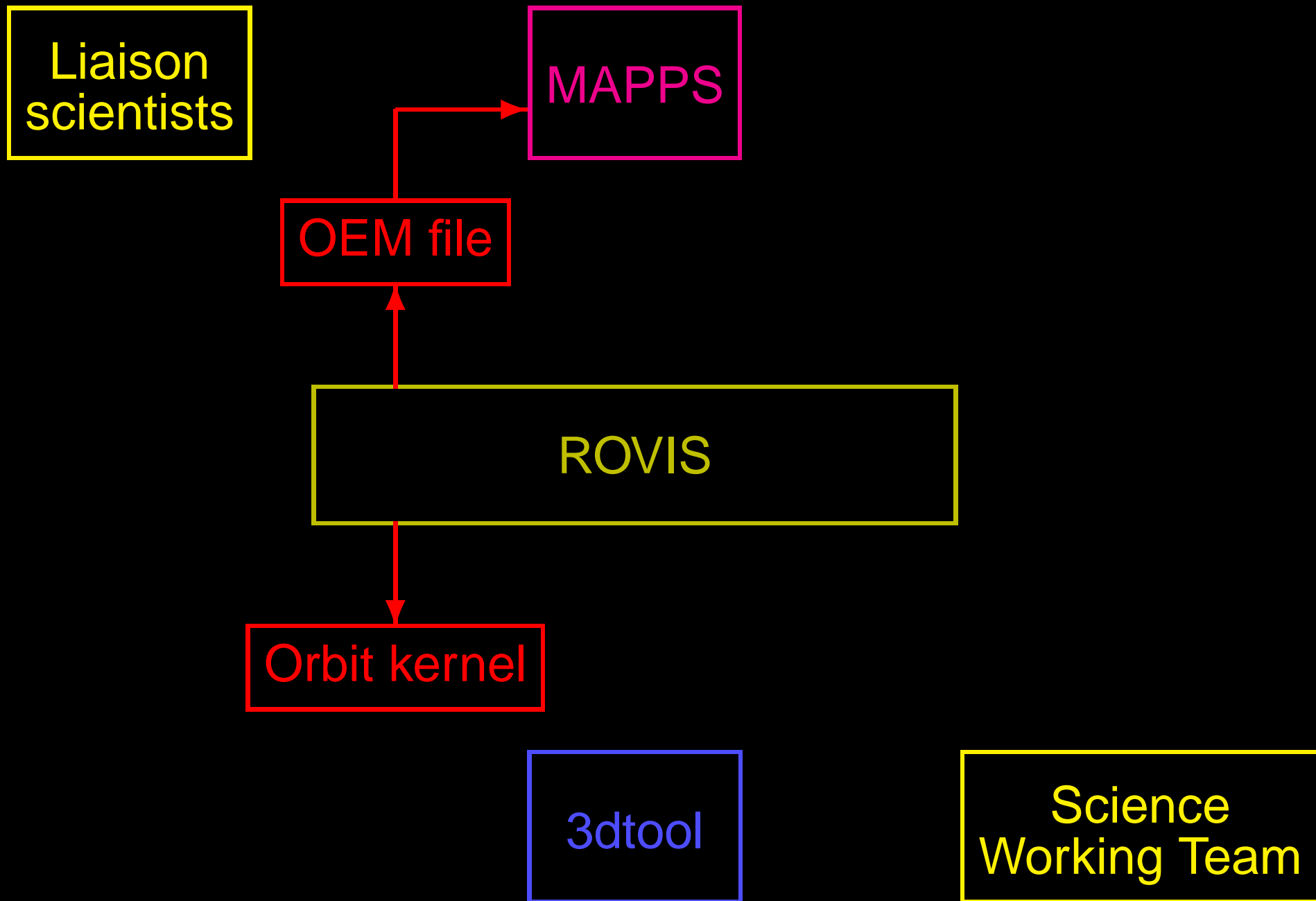

Skeleton Plan Workflow

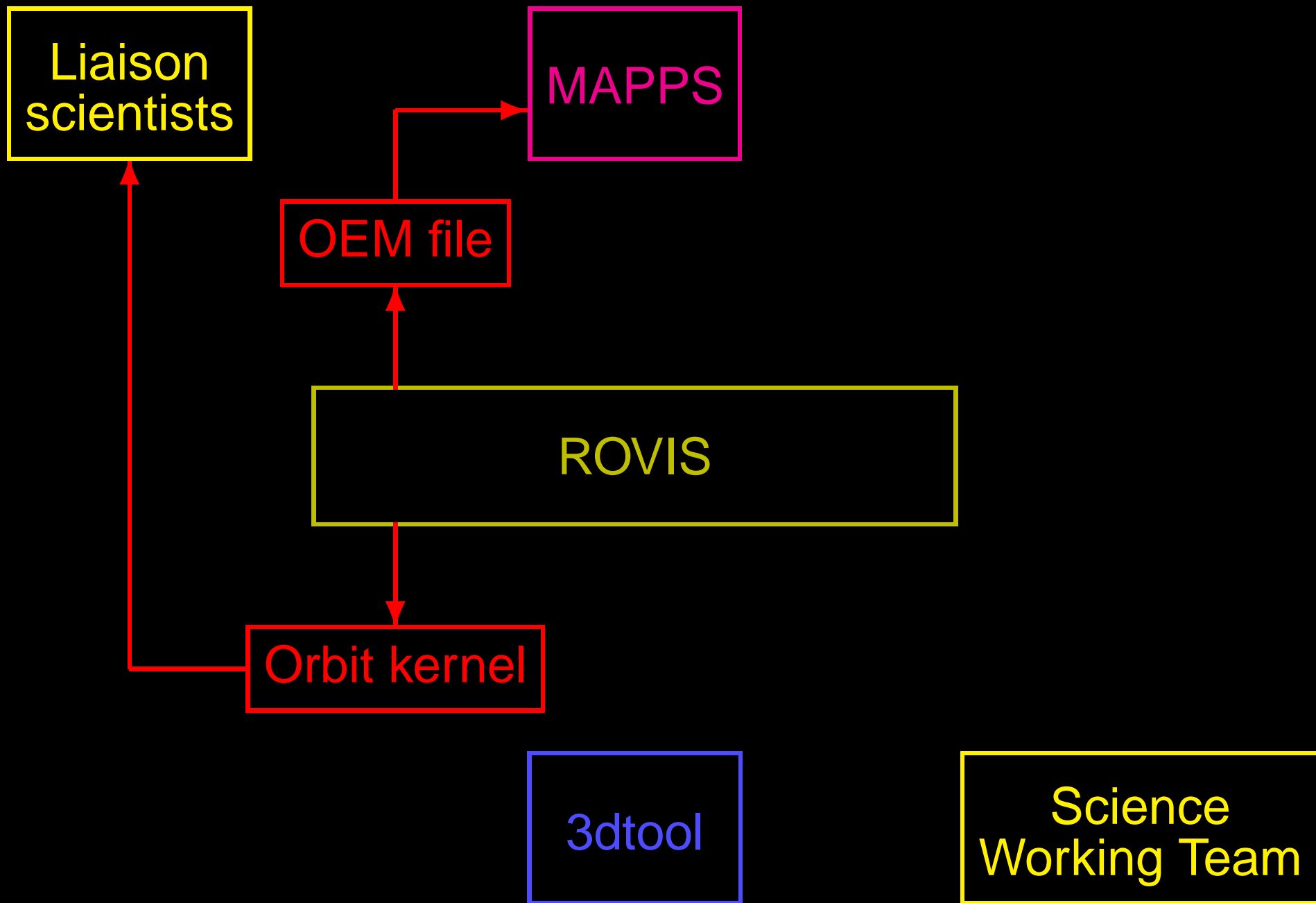

Skeleton Plan Workflow

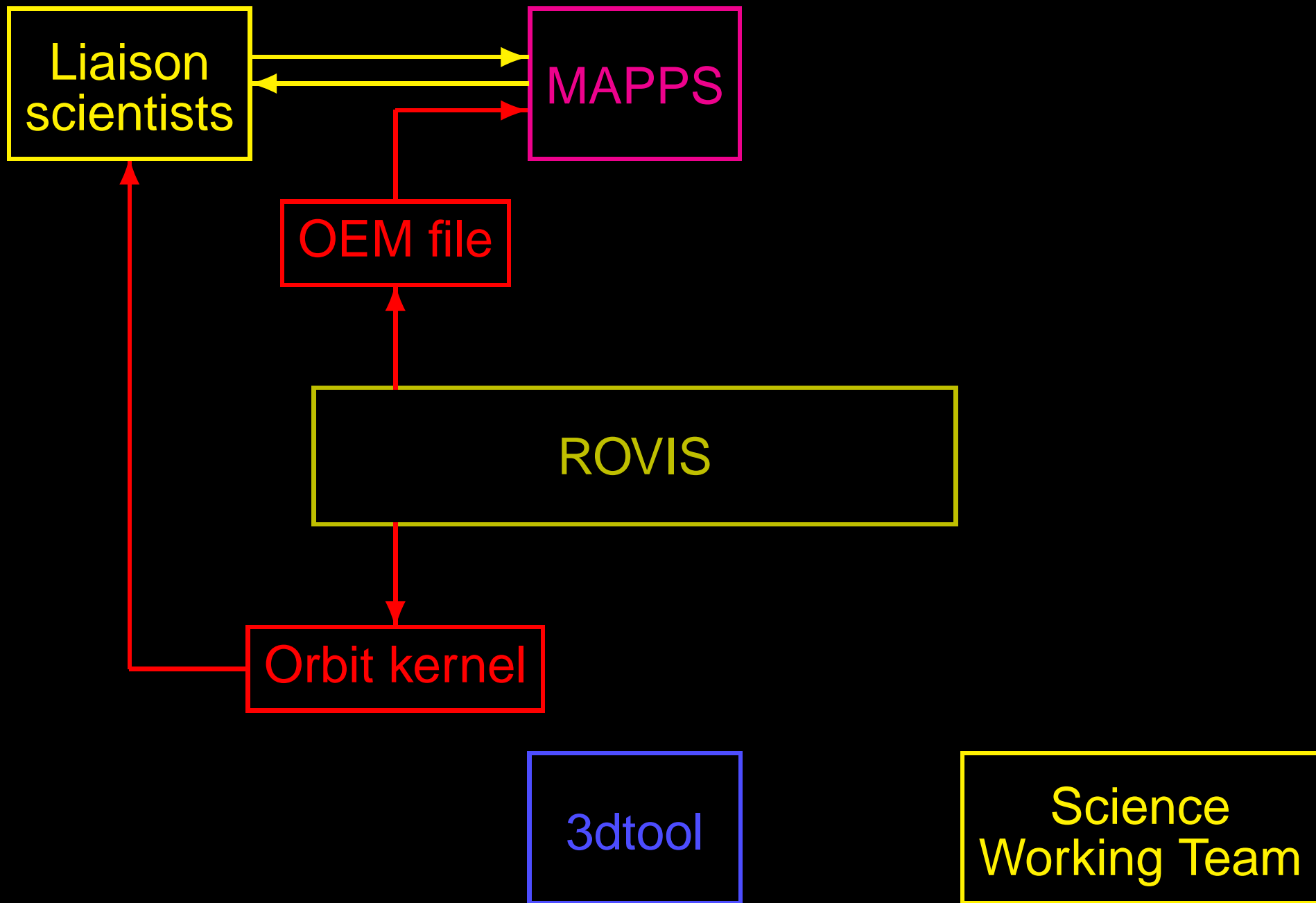

Skeleton Plan Workflow

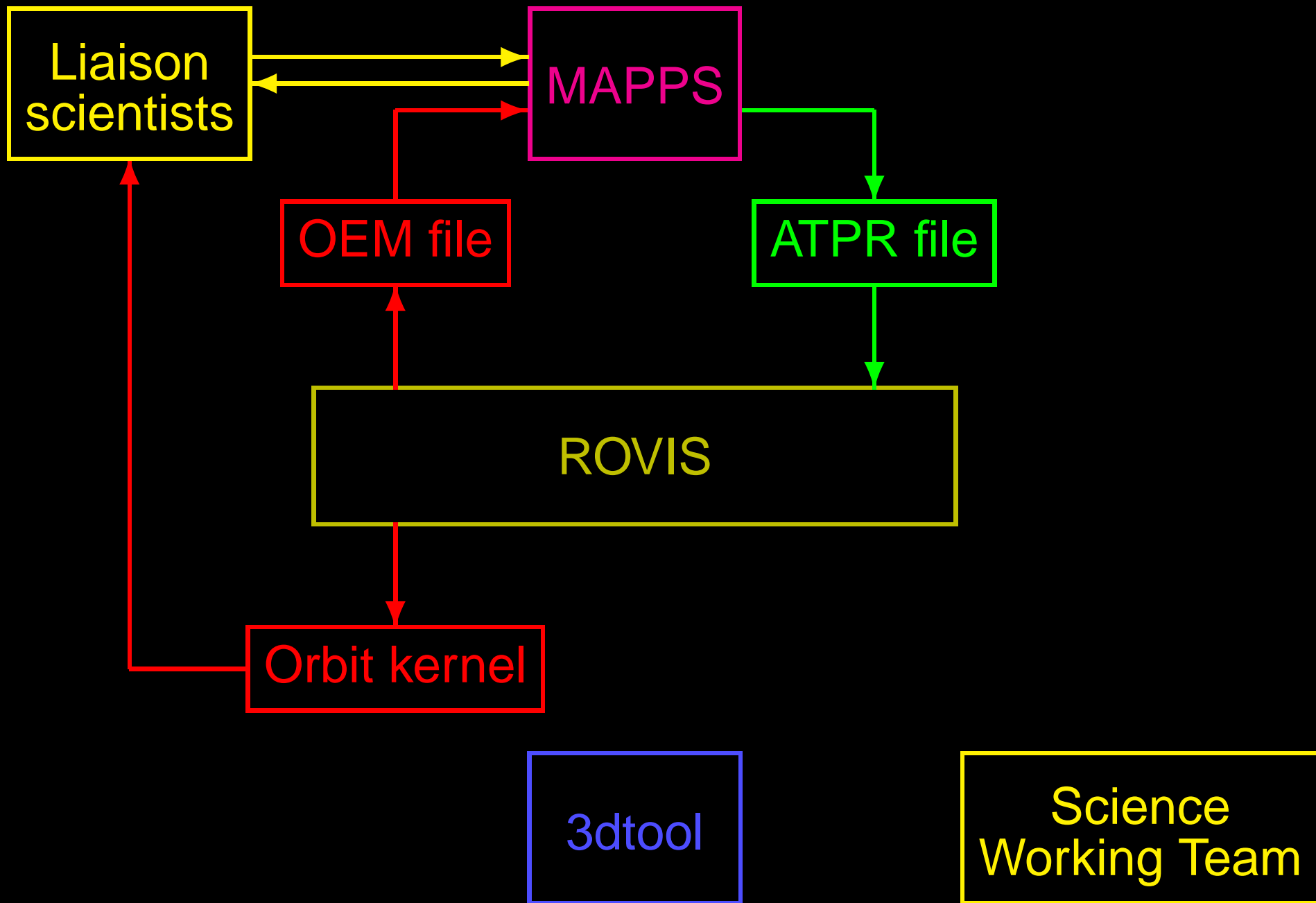

Skeleton Plan Workflow

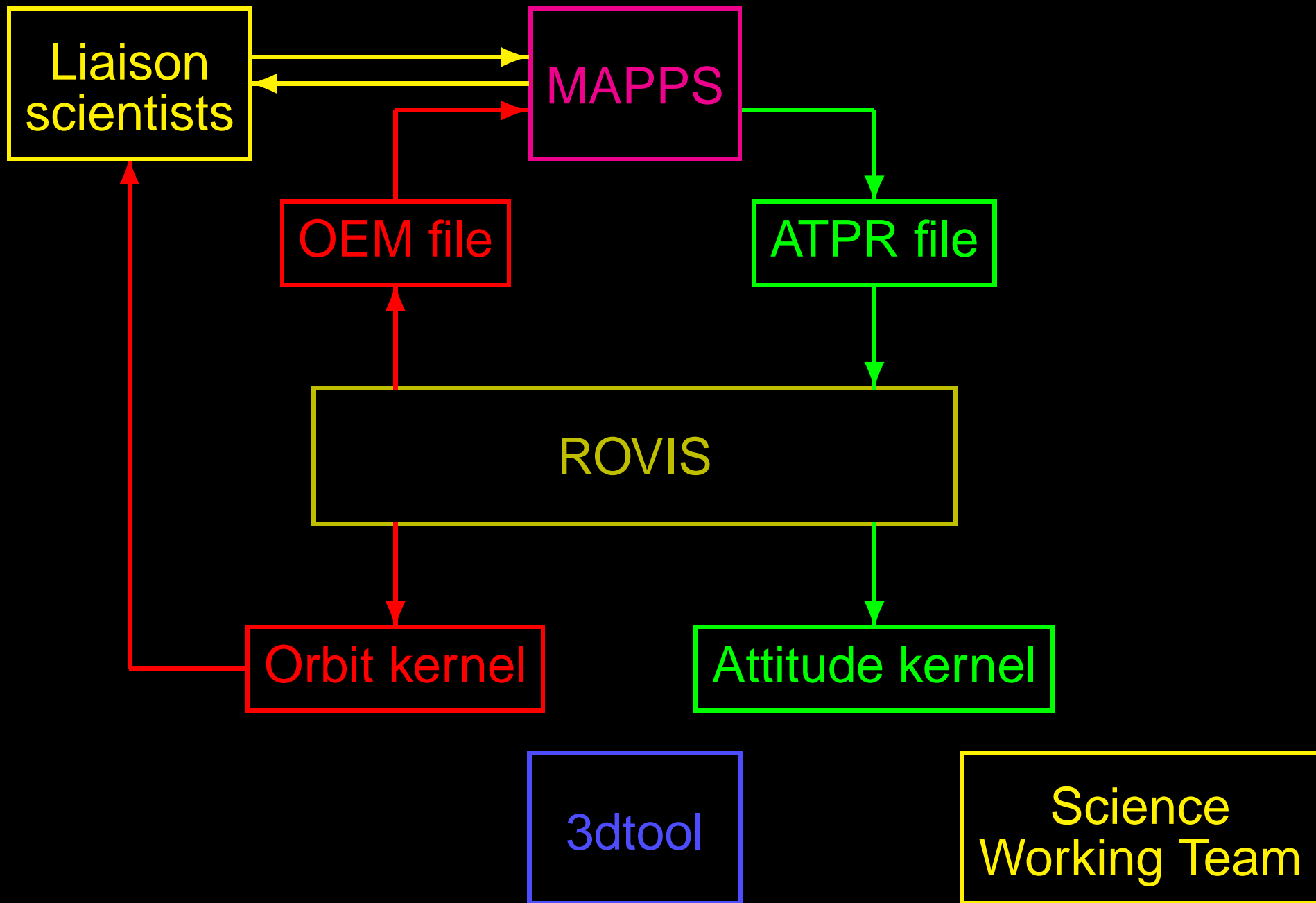

Skeleton Plan Workflow

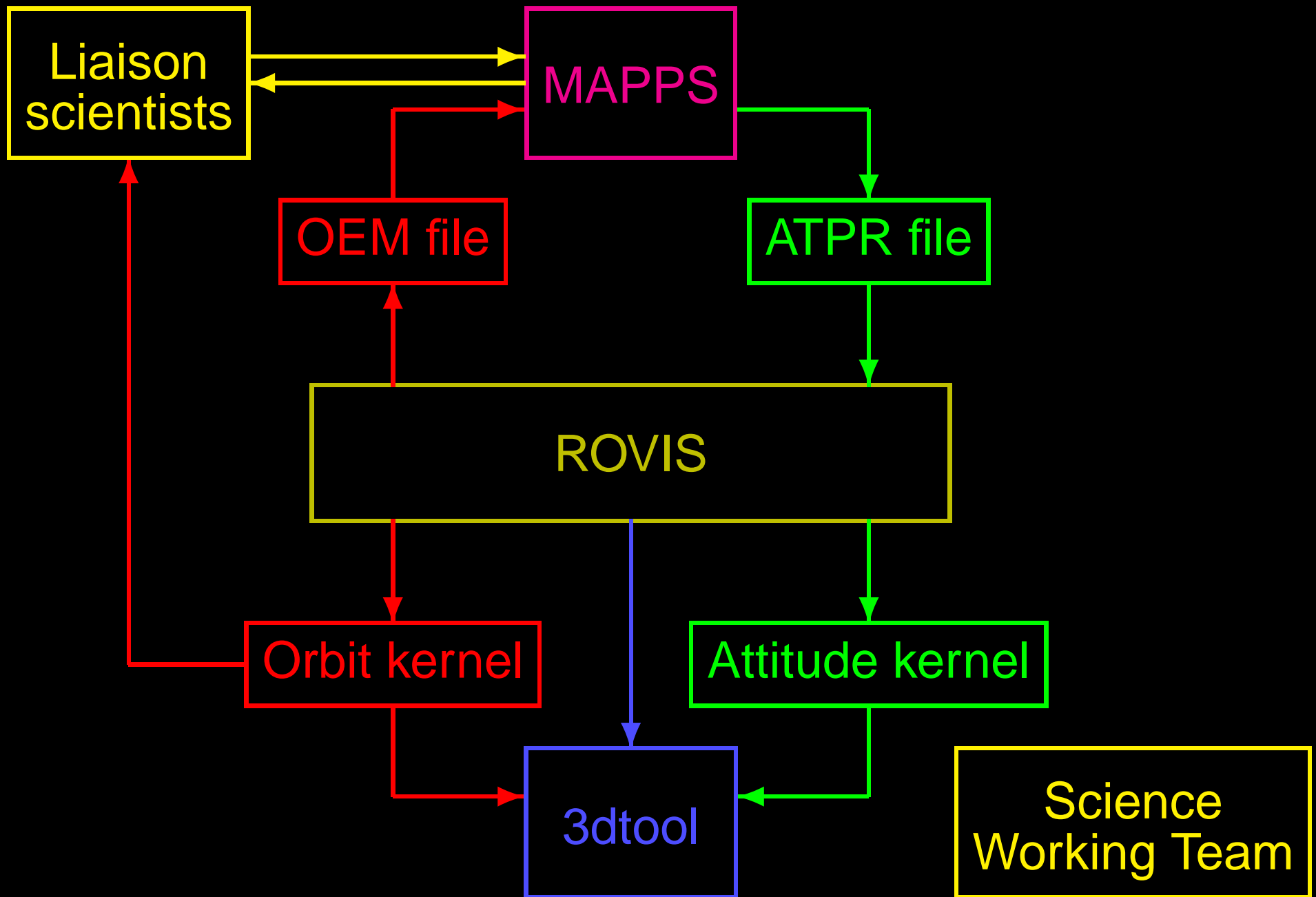

Skeleton Plan Workflow

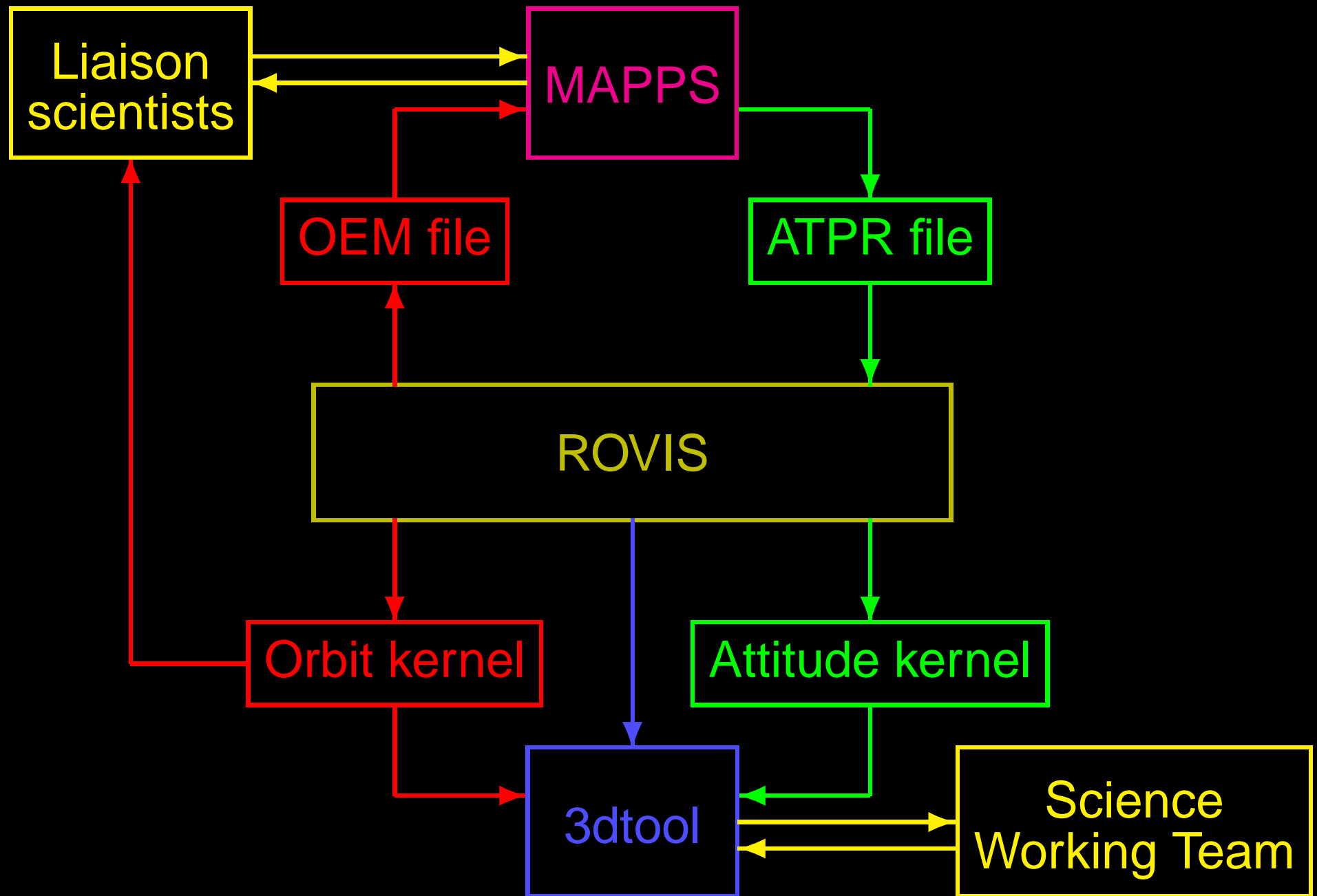

Skeleton Plan Workflow

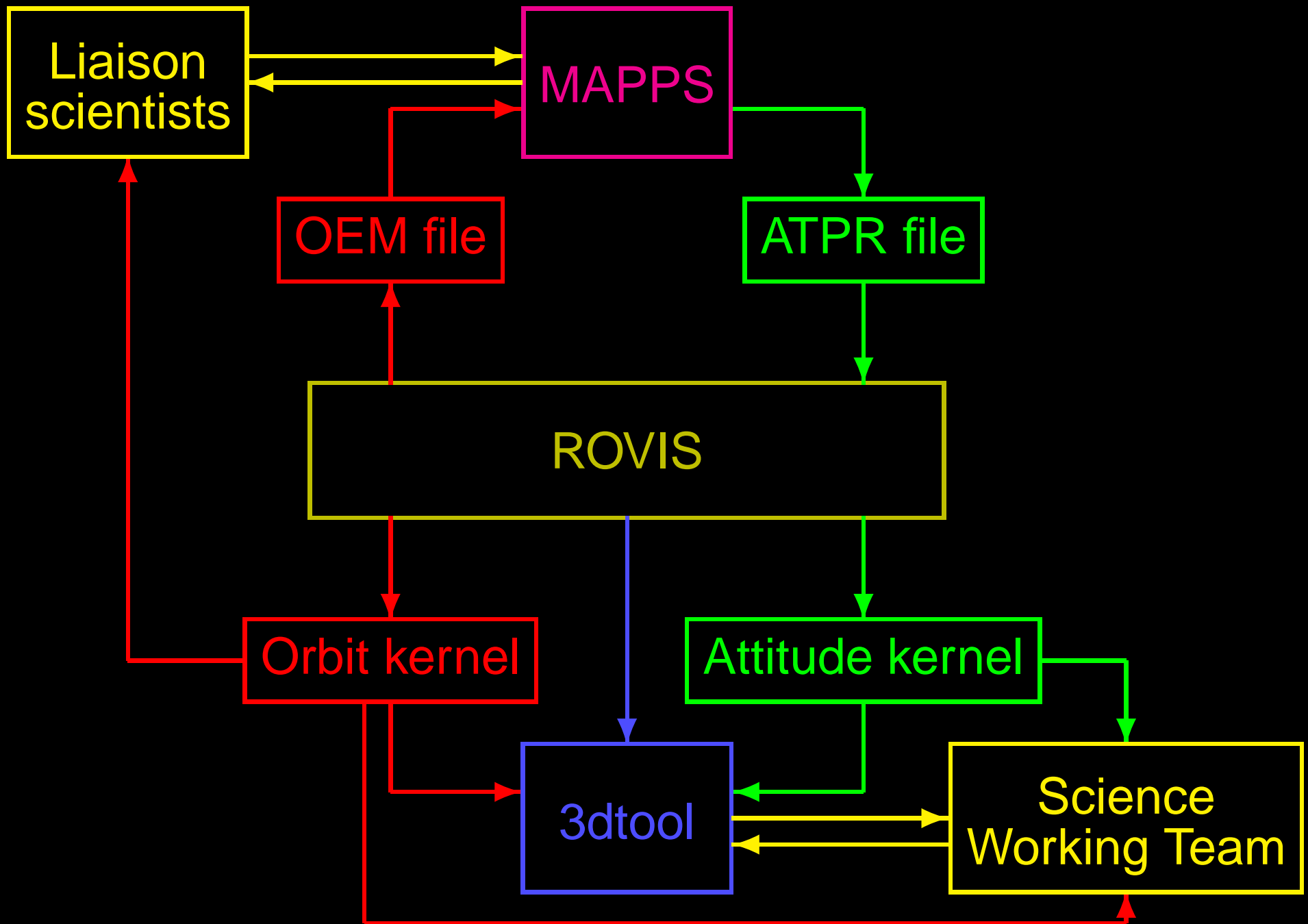

Visualisation example

→ `roviz_2012-01-03.mpg`